

1	2	3	4	
RevNo	Revision note	Date	Signature	Checked
00	Sketch Only	6/16/14	Teresa	Simon

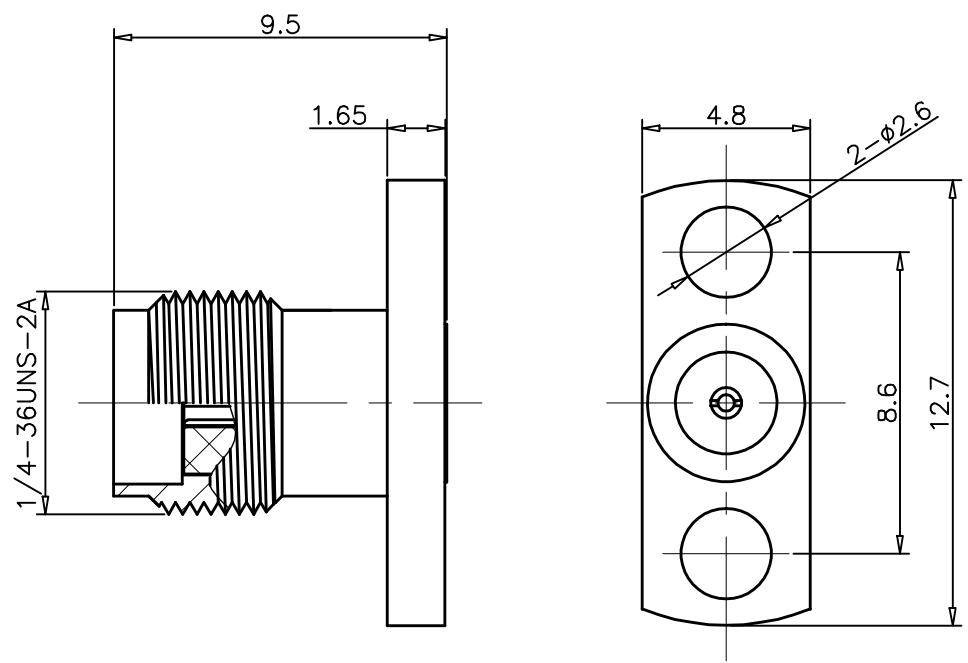

Interface Per: Interface Per: MIL-STD-348, IEC 60169-15
 Material & Finishing:
 1. Center conductor: Beryllium, Gold Plating
 2. Insulators: PTFE
 3. Body : Brass, Gold Plating

ALL DIMENSIONS ARE IN MILLIMETERS AND [INCHES]		Title Super SMA female flange mounted receptacle			
KERUI ELECTRONIC CO;LTD		Drawn by Teresa	Ckd by Simon	Appd by Richard	Date 6/16/2014
THESE DRAWING & SPEC. ARE THE PROPERTY OF KERUI ELECTRONIC CO;LTD AND SHALL NOT BE REPRODUCED, OR COPIED OR USED AS THE BASIS FOR THE MANUFACTURE OR SALE OF APPARATUS OR DEVICES WITHOUT THEIR EXPRESS WRITTEN CONSENT.	UNLESS OTHERWISE NOTED ALL SURFACES FINISHED TO 64/MAX.		Scale 4:1	Sheet 1 of 1	17 1121 052 03
	ALL TOLERANCES ARE:	DECIMALS	FRACTIONS	ANGLES	
	x ± 1.0	±1/64	x' ± 1°		
	x.x ± 0.5		x'x' ± 0.5°		
	x.xx ± 0.1				